

SCHEDA TECNICA GIORGIA

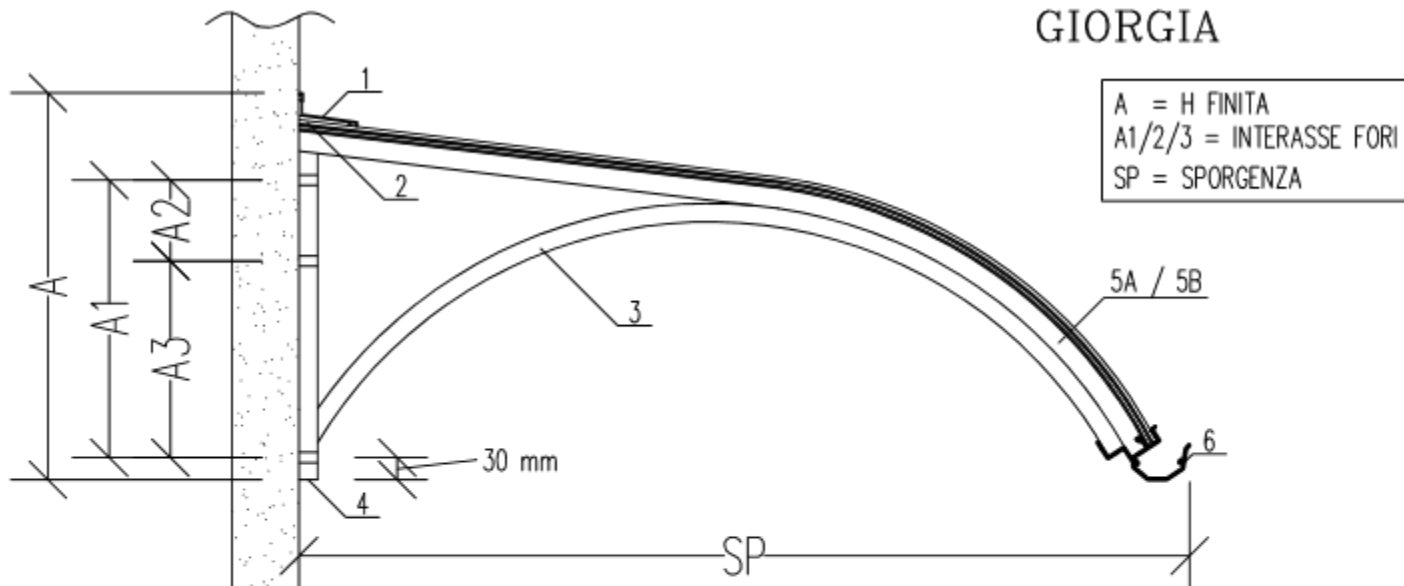

Utilizzare profilo 5B per sporg. 1300/1400 mm passo 2000 mm
Utilizzare profilo 5B per sporg. 1900/2000 mm passo 1000 mm

TABELLA PARAMETRI ARCHI

SP. 650	A 320	A1 160	SP. 900	A 420	A1 260	SP. 1200	A 520	A1 360	SP. 1500	A 600	A1 440	—	SP. 1800	A 770	A2 240	A3 370
SP. 700	A 350	A1 190	SP. 1000	A 470	A1 310	SP. 1300	A 520	A1 360	SP. 1600	A 660	A2 150	A3 345	SP. 1900	A 820	A2 240	A3 415
SP. 800	A 385	A1 225	SP. 1100	A 470	A1 310	SP. 1400	A 565	A1 405	SP. 1700	A 705	A2 190	A3 355	SP. 2000	A 870	A2 240	A3 470

PARTICOLARI COSTRUTTIVI

Polypiu srl a proprio insindacabile giudizio si riserva la possibilità di variare spessori, tipologia e dimensioni senza alcun preavviso.

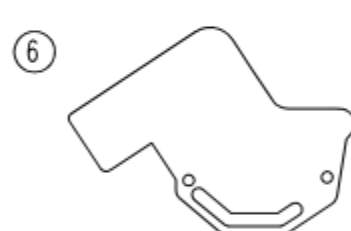
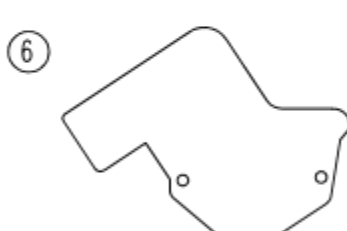
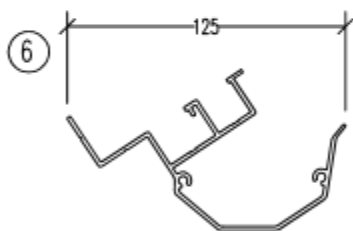
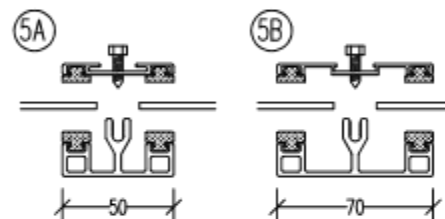
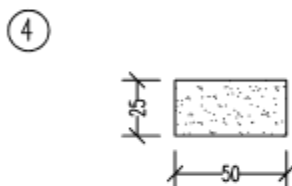
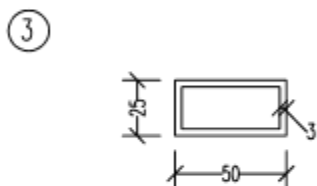
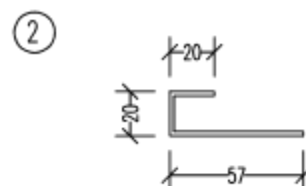
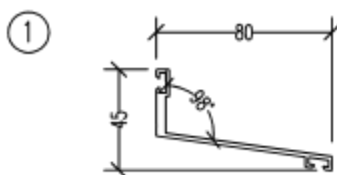

NOTE DI INSTALLAZIONE:

La pensilina è progettata per sostenere i carichi atmosferici come previsto dalla normativa vigente.

Consigliamo comunque di alleggerire la struttura in caso di nevicate eccezionali.

L'idoneità del supporto murario e la tipologia dell'ancoraggio sono da verificarsi a cura del committente.

Descrizione:

Scheda tecnica Giorgia

data: 08/03/16 | Scala: 1:30



SOLUZIONI